



Manual

SI20 Solar Pump Inverter

for AM and PMSM pump

Chapter 1: Safety Requirement and Cautions

To ensure safety of your health, equipment and property, please read this chapter carefully before using the frequency inverter and act in compliance with the instructions when installing, debugging, running and overhauling the frequency inverter.

1.1 Safety Definition

Danger: it will cause danger of serious injuries and even death while operating against the rules.

Caution: it will cause danger of light injuries or equipment destruction while operating against the rules.

Note: some information is useful while operating and use frequency inverter.

1.2 Safety Requirements and Cautions

●Before Installation

Danger
1. Only qualified personnel can operate the equipment. Before operating, be sure to carefully read the manual about safety, installation, operation and maintenance. The safe operation depends on the proper processes of choosing models, carrying, installation, operation and maintenance.

Danger
1. Don't use the damaged or incomplete frequency inverters; Otherwise, there is risk of injury.

●Installation

Danger
1. Please install the frequency inverter on metal or other nonflammable material, and keep it away from the combustible material. Otherwise there is danger of fire;
2. No unauthorized modification to the frequency inverter; Otherwise there is danger of damaged.
3. Normal frequency inverter, which is not explosion-proof, can not be installed where with explosive gas or dust; Otherwise there is danger of explosion.

Attention
1. When two frequency inverters are installed in the same control cabinet, please pay attention to the installing place to guarantee the effective heat dissipation.
2. When carrying the frequency inverter, please support its bottom.

●Wiring**Danger**

1. Wire is connected only when the main circuit is cut off, otherwise there is a danger of shock.
2. Wire is connected by professional person only. Otherwise there is a danger of shock.
3. Earth must be reliable. Otherwise there is a danger of shock.
4. AC power supply should not be connected with output ports U, V, W, otherwise there is a danger of damage to frequency inverter.
5. No drop of bolt, spacer, metal stick, conducting wire or other things into the inner of frequency inverter; Otherwise there is a danger of fire or damage to frequency inverter.

Attention

1. If the damage to frequency inverter or other equipment is caused by improper wiring and utilization or unauthorized alteration, the user should shoulder all responsibilities.
2. Please make sure all wirings meet EMC requirement and satisfy safety standard in the local area; Please refer to recommendations in this manual or national standards of wire diameter to avoid accidents.
3. Static electricity on human body would seriously damage internal MOS transistor, etc. No touch the printed circuit boards, IGBT or other internal devices without anti-static measure, otherwise it will cause the malfunction of frequency inverter.
4. Please don't connect phase shifter capacitance or LC/RC noise filter to the output circuit of frequency inverter; Otherwise it will damage the frequency inverter.
5. Please don't connect the magnetic switch or magnetic contactor to the output circuit of frequency inverter; When frequency inverter is in the operation with load, magnetic switch or magnetic contactor can make inverter over-current protection function act. It will damage frequency inverter seriously.
6. Please don't disassemble the panel cover, it only needs to disassemble the terminal cover when wiring.
7. It is forbidden to do any pressure test on frequency inverter, otherwise it will damage the frequency inverter.

●Before Electrification**Danger**

1. Please make sure that voltage grade of power supply is consistent with frequency inverter's voltage and then check whether the wiring is correct and firm, and whether there is short circuit in peripheral equipment's circuit. Otherwise it will damage frequency inverter and other equipment.
2. Before the frequency inverter is connected to the input power supply, make sure that the cover has been well fixed. Otherwise it will cause electric shock.

3. For the frequency inverters whose storage time is over 1 year, when electrification, the voltage should be raised by booster from low to high. Otherwise it will damage the frequency inverter.

Attention

1. Check if all periphery fittings are wired properly according to the handbook; Otherwise it will cause accidents.

●After Electrification

Danger

1. After electrified, it is forbidden to open the cover, make wiring, and check up; Otherwise, it will cause the danger of electric shock.
2. After electrified, it is forbidden to contact internal wiring board and its parts. Otherwise it will cause the danger of electric shock.
3. Do not operate or touch frequency inverter with wet hand. Otherwise there is danger of damage to frequency inverter and electric shock.

Attention

1. Please set the parameter of frequency inverter cautiously; Otherwise it will damage equipment.

●Operation

Danger

1. Before running, please check and confirm the application range of the machine and equipment once more; Otherwise it will cause accidents.
2. Please don't touch the cooling fan and braking resistance to check the temperature; Otherwise there is a danger of getting burn.
3. Unprofessional workers are banned to check the signals in the running stage; Otherwise it will cause injuries and damage the equipment.

Attention

1. Please don't turn off the equipment by switching off power; Please cut off the power supply after the electric machine stops running; Otherwise it will damage the frequency inverter.
2. Please avoid anything dropping into the equipment when the frequency inverter is running; Otherwise it will cause electric shock.

●Maintenance

Danger

1. Please don't maintain and repair the equipment with electric; Otherwise it will cause electric shock.
2. Before maintaining and repairing the frequency inverter, please make sure the indicator lights of power supply have completely turned off; Otherwise it may cause electric shock and damage the frequency inverter.
3. Persons who have not passed specialized train are not allowed to conduct the frequency inverter maintenance; Otherwise it may cause electric shock and damage the frequency inverter.

1.3 Cautions in Using

1. In application of this series frequency inverter, you have to confirm all machine insulation to prevent damage to the equipment. Moreover, when the motor working in tough environment, please periodic inspect the electrical insulation to ensure the safety of the system work.
2. If the motor adapter is not consistent with frequency inverter's rating current (The rating current of the motor is far smaller than that of frequency inverter), please adjust the protective value to ensure safe running.
3. In occasions such as load raises, usually there is negative torque and frequency inverter breaks off for over-current or over-voltage. In this case, you should consider choosing the matching brake unit.
4. Frequency inverter, in a certain output frequency range, can meet the mechanical resonance of the load equipment. To avoid it, you can set up jumping frequency.
5. As output voltage of the inverter is pulse-wave type, if there is capacity which can improve power factor or pressure-sensitive resistance which used for thunder-proof in the voltage output side, the frequency inverter will break off or its parts will be damaged, so it is necessary to dismantle them. Moreover, it is proposed not install switch parts like air switch and contactor (if it is necessary to install switch on output side, please make sure the output electricity of frequency inverter is zero when the switch is working)
6. At over 1,000 meters altitude, the inverter's heat dissipation function worsened due to the thin air, it is necessary to use less.
7. The inverter output voltage is pulse wave type. If using digital multi-meter measurement, deviation of the reading will be great. And the deviation is different by using different type of digital multi-meter. Under normal circumstances, while RMS 380V, digital multi-meter reading is around 450V.
8. Solar panel can be connected in the series or parallel. For rated voltage 380V controller, we suggest working voltage between 480V and 560V while MPPT. What means the solar panel open circuit voltage should be between 600V and 700V.

1.4 Technical Specification

Solar pump drive power(KW)	Pump motor		Max solar power input (KW)	Max DC input voltage V	Recommnd MPPT voltage (V)	Rated output current (A)	Output frequenc y(Hz)
	Rated power (KW)	Rated voltage (V)					
SI20-D1 series, DC90-400VDC input, 3 phase 110-220VAc output							
0.75	0.75	110	1.0	350	100~350	7A	0-60
1.5	1.5	110	1.95	350	100~350	10A	0-60
SI20-D3 series,DC150V-450V input, 3 phase 220-240VAc output							
0.75	0.75	220	1.0	400	220~400	4A	0-60
1.5	1.5	220	1.95	400	220~400	7A	0-60
2.2	2.2	220	2.86	400	220~400	10A	0-60
4	4	220	5.4	400	220~400	16A	0-60
SI20-D5 series,DC250V to 780VDC input, 3 phase 380-440VAC output							
0.75	0.75	380	1.0	780	480~560	2.5	0-60
1.5	1.5	380	2.2	780	480~560	3.7	0-60
2.2	2.2	380	3.3	780	480~560	5.0	0-60
4	4	380	5.6	780	480~560	10	0-60
5.5	5.5	380	8	780	480~560	13	0-60
7.5	7.5	380	10	780	480~560	17	0-60
11	11	380	14.3	780	480~560	25	0-60
15	15	380	19.5	780	480~560	32	0-60
18.5	18.5	380	23.4	780	480~560	38	0-60
22	22	380	28.6	780	480~560	45	0-60
30	30	380	39	780	480~560	60	0-60
SI20-T3 series,DC350V to 780VDC input,3phase 380-440VAC output							
37	37	380	48.1	780	480~560	75	0-60
45	45	380	58.5	780	480~560	90	0-60
55	55	380	71.5	780	480~560	110	0-60
75	75	380	97.5	780	480~560	150	0-60
93	93	380	120.9	780	480~560	180	0-60
110	110	380	143	780	480~560	210	0-60
132	132	380	171.6	780	480~560	250	0-60
160	160	380	208	780	480~560	310	0-60
185	185	380	240.5	780	480~560	340	0-60
200	200	380	260	780	480~560	380	0-60

1.5 Cautions in Disposal

When you dispose frequency inverter, please pay attention to:

1. Electrolytic capacitor: the electrolytic capacitor of main circuit or the printing plate may explode when they are burned.
2. Plastic: plastic incineration may generate toxic gases.
3. Dispose method: please dispose as industrial waste.

Chapter 2: Installation and Wiring

2.1 Products Appearance and Component Names

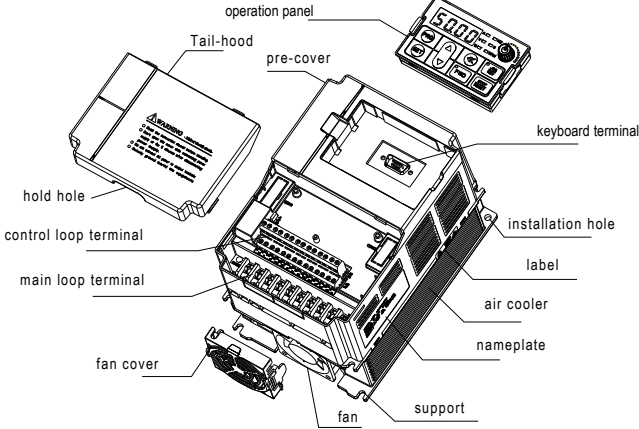

2.2 Dismantlement and Installation of Tail-hood

Installation: First the tail-hood upwardly inclines around 15 degrees and inserts the top fixed flat into the fixed hole in the front cover. Then slightly press the tail-hood downward. While you hear "Ka", it means that the tail-hood is into the place.

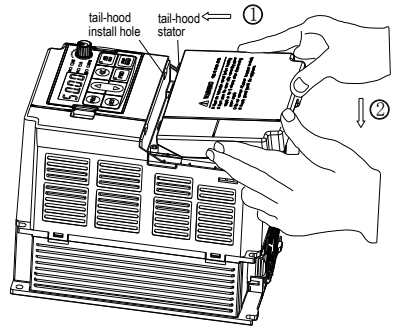

Dismantlement: At the tail of the frequency inverter, there is a special dismantlement hole design. Put your fingers into the hole, upwardly pull the cover with a little force until the buckle between the tail-hood and the crust tear off, and then removed tail-hood down.

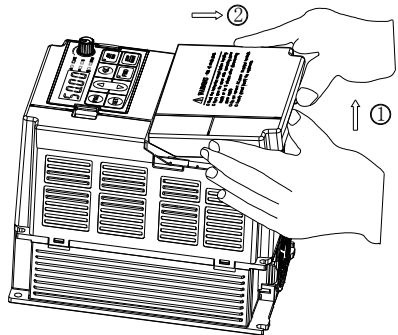

2.3 Dimension of Inverter and Keyboard

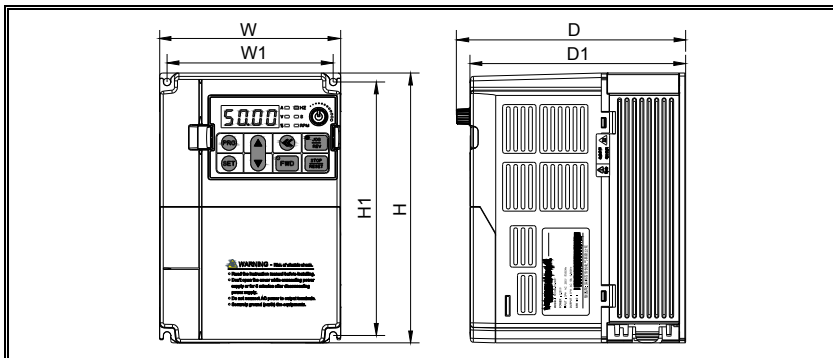

Inverter model	Inverter size			Install size		Install aperture	
	W	H	D	D1	W1		H1
SI20-D1-R75G	122	182	154.5	145	112	171	φ5
SI20-D1-1R5G	159	246	157.5	148	147.2	236	φ5.5
SI20-D3-R75G	122	182	154.5	145	112	171	φ5
SI20-D3-1R5G							
SI20-D3-2R2G	159	246	157.5	148	147.2	236	φ5.5
SI20-D3-004G							
SI20-D5-R75G	122	182	154.5	145	112	171	φ5
SI20-D5-1R5G							
SI20-D5-2R2G							
SI20-D5-004G	159	246	157.5	148	147.2	236	φ5.5
SI20-D5-5R5G							
SI20-D5-7R5G	195	291	167.5	158	179	275	φ7
SI20-D5-011G							

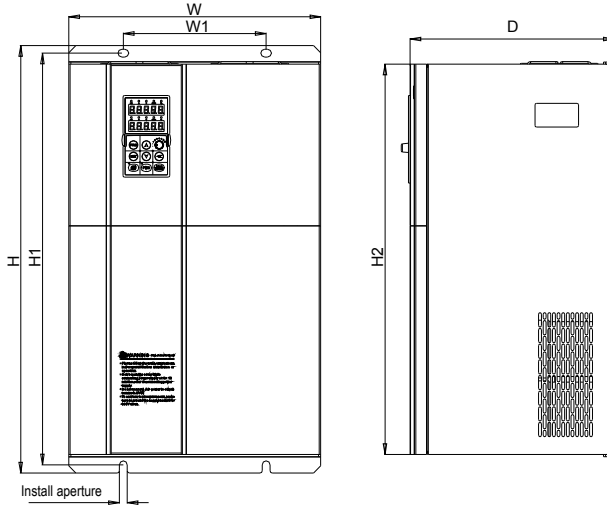

Inverter model	Inverter size				Install size		Install aperture
	W	H	D	H2	W1	H1	
SI20-D5-015G	235	345	200	311	160	331.5	φ7
SI20-D5-018G							
SI20-D5-022G	255	410	225	370	180	395	φ7
SI20-D5-030G							
SI20-T3-037G	305	570	260	522	180	550	φ9
SI20-T3-045G							
SI20-T3-055G							
SI20-T3-075G	380	620	290	564	240	595	φ11
SI20-T3-093G							
SI20-T3-110G							
SI20-T3-132G	500	780	340	708	350	755	φ11
SI20-T3-160G							
SI20-T3-185G	650	1060	400	950	400	1023	φ16
SI20-T3-200G							

2.4 Solar Pump Controller Wiring

● Standard Wiring

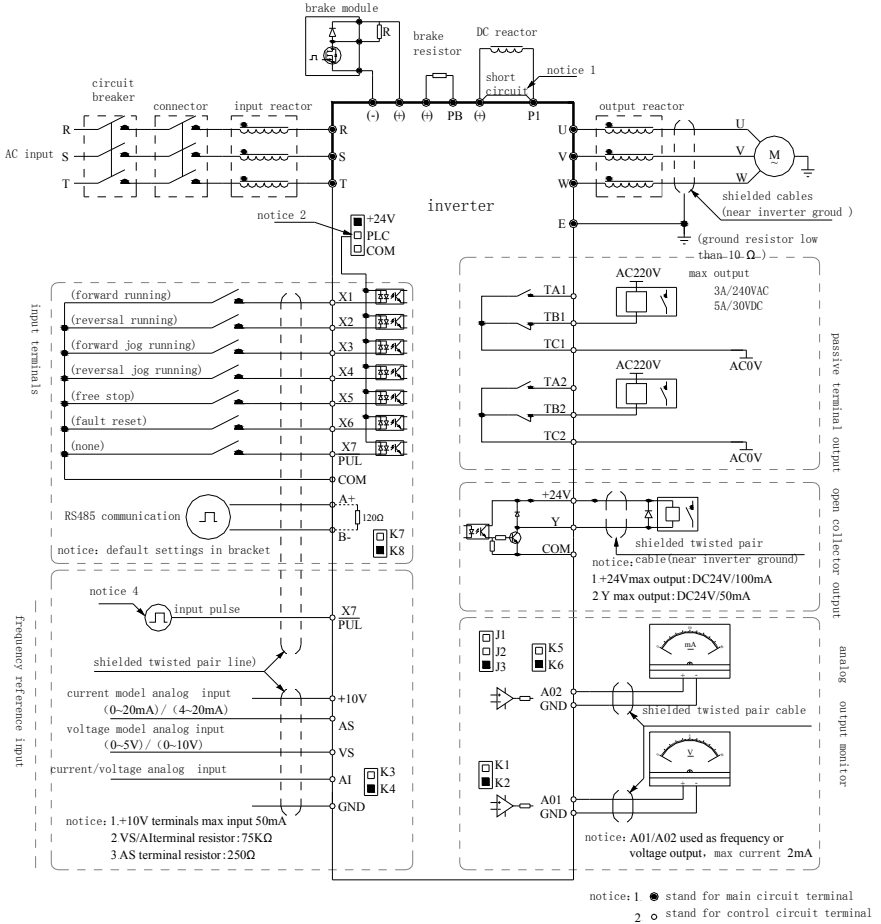

●Auxiliary Terminals Output Ability

Terminals	Function definition	Maximum output
+10V	10V auxiliary power output, form a close loop with GND terminal s	50mA
A01/A02	Analogy monitor output, form a close loop with GND terminal	As for frequency, voltage single, the maximum current is 2mA
+24V	24V auxiliary power supply output, for a close loop with COM	100mA
Y	Open collector output, can be programmable	DC24V/50mA
TA1/TB1/TC1 TA2/TB2/TC2	Passive relay output, can be programmable	3A/240VAC 5A/30VDC

●Switch Illustration and Instruction

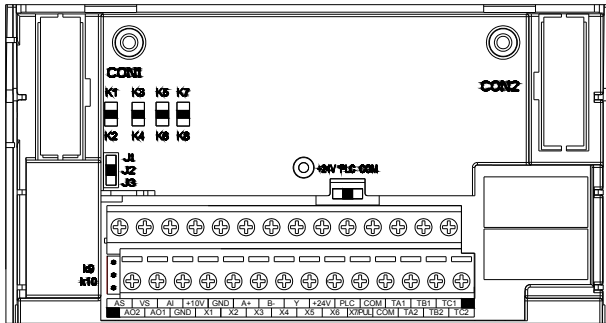

Position	Selection position	Function description
S4	K7	Rs485 communication connecting 120ohm terminals resistor
	K8	RS485 communication disconnect 120ohm terminals
S6	J3	0~10V voltage output
	+24V	+24V and PLC short circuit connecting.
	PLC	PLC connect external power supply input, see fig 3-21, 3-22
	COM	PLC and COM short circuit connect
S7	K9	Disconnect ground GND and PE of shell for circuit discharge
	K10	Connect GND and PE of shell for circuit discharge







Chapter 3: Basic Operation and Trial Run



3.1 Keyboard Layout and Function Specification.

● Keyboard Appearance



● Key Function

Key	Name	Function
	Menu key	Enter menu while standby or running. Press this key to return while modify parameter. While standby or running, press for 1 sec to enter condition monitoring interface.
	Confirm/modify key	Press to modify parameter while in menu interface. Press again to confirm after modifying. While standby or running, press to change LED monitoring items at stop.
	Up/down key	Select parameter group in menu interface. Modify parameter while in modify interface. Modify given frequency, PID, given torque or magnetic powder clutch given torque while at standby or condition monitoring state.
	Shift key	Select digit of function no modified by up/down key; Select parameter digits modified by up/down key. Change LED monitoring items while standby or running.
	Forward run key	While run/stop is controlled by keyboard, press this key, the inverter forward rotate and the indicator is always on. While reverse, the indicator sparks.
	Jog/reverse key	This key function can be defined by parameter [E-08]. Press it, machine reverses and indicator is off if this key is defined as REVERSE. Machine will jog and indicator is on if this key is defined as JOG.

	Stop/reset key	Machine stops if press it while run/stop is controlled by keyboard. Its efficiency range is defined via function no [F-07]. Inverter resets if press it in fault state (no reset if fault is not solved).
	Keyboard potentiometer	Can be used as input channel for given frequency, upper frequency limit, given torque, given PID or PID feedback setting.

● Indicator Light Meanings

	Name	State	Meaning
Unit indicator light	Hz	Spark	Digital display given frequency.
	Hz	On	Digital display output frequency.
	A	On	Digital display actual output current.
	V	On	Digital display input voltage.
	V	Spark	Digital display output voltage.
	S	On	Time unit is second.
	S	Spark	Time unit is ms, min, or h.
	RPM	On	Digital display motor speed.
	%	Spark	Digital display given PID.
%	On	Digital display PID feedback.	
State indicator light	FWD	On	Inverter is forward rotating.
	FWD	Spark	Inverter is reverse rotating.
	FWD	Off	Inverter stops.
Function indicator light	REV/JOG	On	Jog.
	REV/JOG	Off	Reverse.

3.2 Basic Operation

●Parameter Initialization

Setting F0.19 = 1 to complete the initialization of parameters. Specific operations as follows:

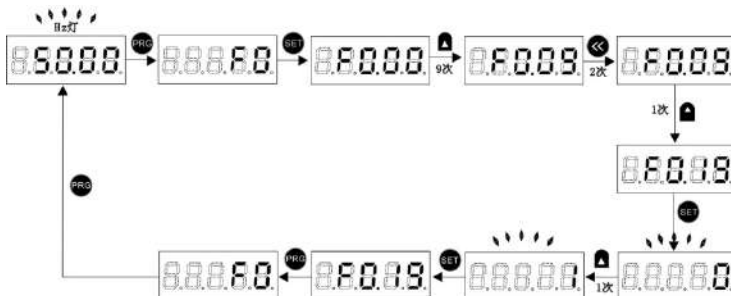

● Core Control Mode Selection

Here by setting F0.00 = 0 (VC without PG) as an example to introduce,

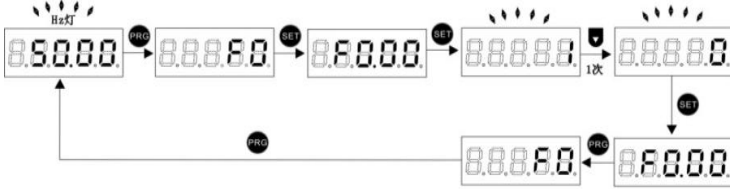

● Motor Parameter Settings

According to the motor nameplate [F5.02] (Motor rated power), [F5.03] (motor rated frequency), [F5.04] (motor rated speed), [F5.05] (motor rated Voltage).

Other motor parameters can be obtained through self-learning of the inverter, the specific methods of operation are as follows:

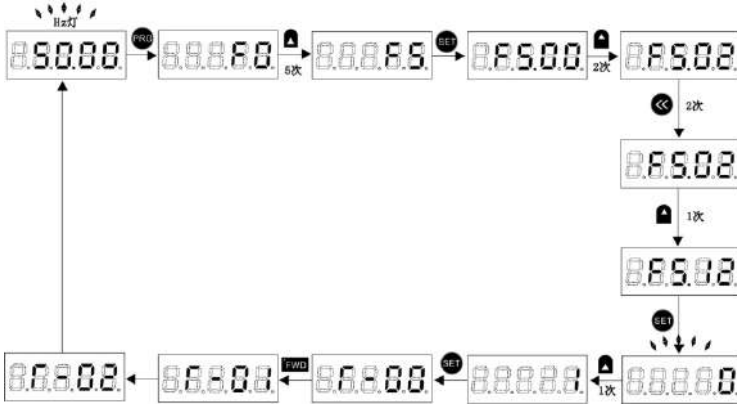



Chapter 4: Fault Diagnosis and Solution

This chapter describes the inverter fault, alerts, and operation of the failure on the inverter, the display information on inverter and countermeasures. In addition, the poor condition of the drive and motor failures will be briefly described in this chapter. Tuning guide on commissioning of the drive please refer this chapter.

4.1 Fault Type

Type	Solar drive action when fault happen
Solar drive fault	<p>If any fault has been detected, it will occur following states.</p> <ul style="list-style-type: none"> ● Fault information will be show in keypad ●The output of solar drive will be cut off, and motor coast to stop. ●When Function code [F2.29] set to 3 (fault output), the Y collector terminals output is ON. ●When the [F2.31\F2.31] set to 3 (fault output), TA1~TC1、TA2~TC2 terminals output ON passive digital output, TB1~TC1,TB2~TC2 output OFF passive digital output ● If there are over load (OL0, over current (OC), system abnormal (SC), over voltage (OU), under voltage during running, and if [FA.22] is not set to 0, the solar drive will restart after [FA.23] time.
External fault	<p>In some application case, introduce the external fault to solar drive system as for monitoring, protecting, switching purpose. If one multiple programmable terminals set for external fault input. When external input signal is valid, the solar drive will be trip and sent out fault alarm.</p>









4.2 Fault Information and Description in Detail

Keypad display	Fault code	Fault type	Possibility reason	Troubleshooting
	E.LU2	Under voltage at runs	<ul style="list-style-type: none"> ●Power voltage too low ●DC main contactor don't close 	<ul style="list-style-type: none"> ●Check input power to solve ● Ask support
	E.oU1	Over voltage at acceleration	<ul style="list-style-type: none"> ●Power voltage fluctuation over limit ●Too start rotating motor 	<ul style="list-style-type: none"> ● Check power grid ● Restart until motor is stop completely, or set [F1.00] set for 1 or 2
	E.oU2	Over voltage during deceleration	<ul style="list-style-type: none"> ●Deceleration time too small ●The driving load too heavy ●Power voltage fluctuation over limit 	<ul style="list-style-type: none"> ●Prolong deceleration time ●Reduce the load, or select bigger capacitor drive, or connect braking unit ● Check input power

E.oU3	E.oU3	Overvoltage at constant speed	<ul style="list-style-type: none"> ●The input voltage is too high. ●An external force drives the motor during deceleration 	<ul style="list-style-type: none"> ●Adjust the voltage to normal range. ●Cancel the external force or install the braking resistor.
E.oU4	E.oU4	Over voltage at stop	<ul style="list-style-type: none"> ●Voltage fluctuate above limit 	<ul style="list-style-type: none"> ● Check the input voltage
E.oC1	E.oC1	Over current during acceleration	<ul style="list-style-type: none"> ●Acceleration time is too short ●To start rotating motor ●V/F setting not correct or torque boost setting too big ●Solar drive capacitor is too small 	<ul style="list-style-type: none"> ●Prolong acceleration time ●Restart motor when it on still, or set f1.00 for 1 or 2. ● Reset V/f curve or torque boost setting
E.oC2	E.oC2	Over current during deceleration	<ul style="list-style-type: none"> ●The output circuit is grounded or short circuited. ●Motor auto-tuning is not performed. ●The acceleration time is too short. ●Manual torque boost or V/F curve is not appropriate. ● The voltage is too low. ●The startup operation is performed on the rotating motor. ●A sudden load is added during acceleration. ●The AC drive model is of too small power class. 	<ul style="list-style-type: none"> ● Eliminate external faults. ●Perform the motor auto tuning. ● Increase the acceleration time. ● Adjust the manual torque boost or V/F curve. ● Adjust the voltage to normal range. ● Select rotational speed tracking restart or start the motor after it stops. ● Remove the added load. ● Select an AC drive of higher power class.
E.oC3	E.oC3	Over current at constant speed	<ul style="list-style-type: none"> ●The output circuit is grounded or short circuited. ●Motor auto-tuning is not performed. ●The voltage is too low. 	<ul style="list-style-type: none"> ● Eliminate external faults. ●Perform the motor auto tuning. ●Adjust the voltage to normal range.

			<ul style="list-style-type: none"> ● A sudden load is added during operation. ●The AC drive model is of too small power class 	<ul style="list-style-type: none"> ● Remove the added load. 5: Select an AC drive of higher power class.
E.oL1	E.oL1	Motor overload	<ul style="list-style-type: none"> ● Boost torque is too big under VF control ●ACC. and DEC. time is too short ●Motor parameters setting is improperly ●Restart motor which in counter rotate ●The grid voltage is too lower ●Load is too big or motor block load ●AC drive selected is too load 	<ul style="list-style-type: none"> ●Reduce boost torque ●Increase the ACC./DEC. time ● Reset motor parameters ●Reduce current limit and adopt speed tracking ● Check grid voltage ● Check load condition ●Change bigger power AC drive
E.oL2	E.oL2	AC drive overload	<ul style="list-style-type: none"> ●Boost torque is too big under VF control ●ACC. and DEC. time is too short ●Motor parameters setting is improperly ●Restart motor which in counter rotate ●The grid voltage is too lower ●Load is too big or motor block load ●AC drive selected is too load 	<ul style="list-style-type: none"> ●Reduce boost torque ● increase the ACC./DEC. time ●reset motor parameters ●Reduce current limit and adopt speed tracking ● Too check grid voltage ●Too check load ●change bigger power AC drive
E.SC	E. SC	System abnormal	<ul style="list-style-type: none"> ●Deceleration is too short ●Short circuit of solar drive output or phase output short circuit to ground ● Module damage ● EMC interface 	<ul style="list-style-type: none"> ● Prolong acceleration time ● To check peripheral equipment ● Ask to support ● Check the wiring layout, cable ground

E.oH1	E.oH1	Inverter over-heat	<ul style="list-style-type: none"> ●Temperature is too high. ● Air channel is blocked. ● Fan connection parts is loose. ● Fan is damaged. ●Temperature detection circuit fault。 	<ul style="list-style-type: none"> ● Make the environment meet the requirement. ● Clear the air channel. ● Check and reconnect the wire ● Change the same new fan. ● Seek support from factory.
E.oH2	E.oH2	Rectifier over-heat	<ul style="list-style-type: none"> ●Temperature is too high. ● Air channel is blocked. ● Fan connection parts is loose. ● Fan is damaged. ● Temperature detection circuit fault 	<ul style="list-style-type: none"> ●Make the environment meeting the requirement. ● Clear the air channel. ● Check and reconnect the wire. ● Change the same new fan. ● Seek support from factory.
E.FE1	E.TE1	Motor static detection fault	<ul style="list-style-type: none"> ● Detection overtime ●Start static detection while motor is running. ● Capacitance difference is too big between motor and inverter. ●Motor parameter setting mistake. 	<ul style="list-style-type: none"> ● Check motor connection wire. ● Detect after motor stopping totally. ● Change inverter model. ● Reset parameter according to nameplate.
E.FE2	E.TE2	Motor rotation detection fault	<ul style="list-style-type: none"> ●Detect while motor is running. ● Detect with load. ● Detection overtime ●Capacitance difference is too big between motor and inverter. ●Motor parameter setting mistake. 	<ul style="list-style-type: none"> ● Detect after motor stop totally. ● Re-detect without load. ● Check motor connection wire. ● Change inverter model. ● Reset parameter according to nameplate.
E.EEP	E.EEP	Memory fault	<ul style="list-style-type: none"> ●Electromagnetic disturb in memory 	<ul style="list-style-type: none"> ● Resume load and save.

			period. ● EEPROM damage.	● Seek support from factory.
	LIFE	Reserved		
	E.ILF	Input phase loss	●3-phase input power open phase.	●Check 3-phase power supply and the phase. ●Check 3-phase power supply wiring.
	E.oLF	Output phase loss	●3-phase output power open phase	● Check 3-phase output voltage and current. ● Check wiring.
	E.Gnd	● Output earth terminal short circuit.	●Check wiring and insulation.	●Output earth
	E.HAL	Current detection fault	● Detect circuit fault. ● Phase imbalance	●Seek support from factory ● Check motor and wiring.
	E.PAn	Keyboard connect fault	● Keyboard wire fault. ●Keyboard component damage.	● Check keyboard wire. ●Seek support from factory.
	Rs485 communication fault	● Unsuitable baud rate setting. ●Communication wire breaks. ●Communication format does not match upper machine.	●Set suitable baud rate setting. ●Check communication wire. ●Make sure right communication format.	●RS485communication fault
	E.CPE	Parameter copy fault	●Parameter copy communication is fault. ●Copy keyboard does not match the inverter.	● Check wire. ●Select the specified external keyboard model.

Chapter 5 Parameters List

- “●”: Stands for parameters can modify during running.
 “○”: Stands for parameters can't modify during running
 “x”: Stands for parameter read only, can't modify
 “-”: Stands for factory parameters, only for factory
 “※”: Stands for relative with AC drive models.

★ Basic Function Parameter

Function code	Function name	Setting range and definition	Default setting	property	Comm. Add
F0.00	Control mode	1 : AM linear VF control without PG 6 : Voltage vector control without PG for PMSM	1	○	0x000
F0.02	Running control mode	0 : Key board control 1 : Terminal control	0	○	0x002
F0.03	Main frequency source X reference	0 : digital reference of keyboard 1 : Potentiometer of key board 8 : PID control reference	0	○	0x003
F0.08	Digital frequency reference	0.00 ~ maximum frequency	50.00Hz	●	0x008
F0.09	Maximum frequency	0.00 ~ 320.00Hz	50.00Hz	○	0x009
F0.11	Upper limit frequency	Lower limit frequency ~ Maximum frequency	50.00Hz	●	0x00B
F0.12	Lower limit frequency	Upper limit frequency	0.00Hz	●	0x00C
F0.14	Acceleration time 1	0.01 ~ 650.00s	Per model	●	0x00E
F0.15	Deceleration time 1	0.01 ~ 650.00s	Per model	●	0x00F
F0.16	Rotation direction	0 : As same as forward 1 : Runs in reverse 2 : Forbidden reverse	0	●	0x010
F0.17	Carrier frequency	0.6 ~ 15.0kHz	Per model	●	0x011
F0.19	Factory setting	0 : No operation 1 : Restore to default(motor parameters don't restore) 2 : Clear fault record 3 : Restore to default(motor parameters restore)	0	○	0x013

★ Running Control Parameters

Function code	Function name	Setting range and definition	Default setting	property	Comm. Add
F1.07	Stop mode	0 : Acceleration to stop 1 : Free stop	0	●	0x107
F1.13	Acceleration/deceleration mode	LED unit's digit, acceleration/deceleration time reference 0 : Maximum frequency 1 : Fixed frequency LED ten digit : Acceleration/deceleration mode 0 : Linear 1 : S curve LED thousands digit : Reserve LED thousands digit : Reserve	0000	○	0x10D
F1.31	Terminal running protection function	LED unit's digit : Terminal running protection function 0 : Terminals control is disable when power on 1 : Terminals control is enable when power on LED ten digit, switchover between terminal and communication 0 : When switching the terminal control is disable 1 : When switching the terminal control is enable	0011	●	0x11F

★ Switch Terminal Parameters

Function code	Function name	Setting range and definition	Default setting	property	Comm. Add
F2.00	X1 terminals function define	0 : No function 1 : Forward 2 : Reverse 6 : Free stop 7 : Emergency stop 8 : Fault reset 9 : Output fault reset 10 : Frequency increase (UP) 11 : Frequency increase (DW) 22 : PID cancel 23 : PID control pause	1	●	0x200

F2.01	X2 terminals function define	See X1	2	●	0x201
F2.02	X3 terminals function define	See X1	4	●	0x202
F2.03	X4 terminals function define	See X1	5	●	0x203
F2.04	X5 terminals function define	See X1	6	●	0x204
F2.05	X6 terminals function define	See X1	8	●	0x205
F2.06	X7 terminals function define	See X1	10	●	0x206
F2.29	Output terminal (Y)	0 : No output 1 : Frequency running 2 : Frequency in reverse 3 : Fault and trip alarm 1(alarm during fault reset period)	1	●	0x21D
F2.30	Relay output 1 (TA1-TB1-TC1)	See Y	1	●	0x21E
F2.31	Relay output 2 (TA2-TB2-TC2)	See Y	3	●	0x21F

★ **Keyboard and Display Parameters**

Function code	Function name	Setting range and definition	Default setting	property	Comm. Add
F4.00	Parameters and button lock selection	0 : No lock 1 : Function parameters lock 2 : Function code and parameters lock (except RUN/STOP/JOG) 3 : Function parameters all lock	0	●	0x400
F4.01	User password	0 ~ 9999	0	●	0x401
F4.02	Keypad REV/JOG select	0 : REV 1 : JOG	0	●	0x402
F4.05	Function copy	0 : No operation 1 : Sent parameter to keypad and store 2 : Sent stored parameters to keypad to AC drive	0	○	0x405

F4.11	The first line of keypad display in running status	LED unit digit : First group display 0 : Frequency reference 1 : Output frequency reference 2 : Output voltage 3 : Input voltage 4 : Output voltage 5 : Machine speed 6 : Reserve 7 : Output torque 8 : PID reference 9 : PID feedback A : Output power B : DC bus voltage C : IGBT module temperature 1 D : IGBT module temperature 2 E : Input terminal X ON/OFF state F : Output terminal Y ON/OFF state	42B1	●	0x40B
F4.11	The first line of keypad display in running status	LED 1 digit : The first group LED 10 digit : The second group LED 100 digit : The third group LED 1000 digit : The fourth group	42B1	●	0x40B
F4.12	The first line of keypad display at stop status	LED 1 digit : The first group LED 10 digit : The second group LED 100 digit : The third group LED 1000 digit : The fourth group	42B0	●	0x40C
F4.13	The second line of keypad display in running status	LED 1 digit : The first group LED 10 digit : The second group LED 100 digit : The third group LED 1000 digit : The fourth group	CA42	●	0x40D
F4.14	The second line of keypad display at stop status	LED 1 digit : The first group LED 10 digit : The second group LED 100 digit : The third group LED 1000 digit : The fourth group	CA42	●	0x40E

★ Motor Parameters

Function code	Function name	Setting range and definition	Default setting	property	Comm. Add
F5.00	Motor type	0 : Asynchronous motor (AM) 1 : Permanent magnet motor (PM)	0	×	0x500
F5.01	Poles of motor	2 ~ 48	4	○	0x501
F5.02	Rated power of motor	0.4 ~ 1000.0kW	Per model	○	0x502

F5.03	Rated frequency of motor	0.01 ~ maximum	Per model	○	0x503
F5.04	Rated speed of motor	0 ~ 65000rpm	Per model	○	0x504
F5.05	Rated voltage of motor	0 ~ 1500V	Per model	○	0x505
F5.06	rated current of motor	0.1 ~ 2000.0A	Per model	○	0x506
F5.07	Motor no load current	0.01 ~ 650.0A	Per model	○	0x507
F5.08	Stator resistance (asynchronous motor)	0.001 ~ 65.000	Per model	○	0x508
F5.09	Rotor resistance (asynchronous motor)	0.001 ~ 65.000	Per model	○	0x509
F5.10	Leakage inductive inductance (asynchronous motor)	0.1 ~ 6500.0mH	Per model	○	0x50A
F5.11	Mutual inductive inductance (asynchronous motor)	0.1 ~ 6500.0mH	Per model	○	0x50B
F5.12	Motor auto tuning	0 : No operation 1 : Rotation auto tuning 2 : Stationary auto tuning	0	○	0x50C
F5.21	Stator resistance Of synchronous motor	0.001 ~ 65.000	Per model	○	0x515
F5.22	Shaft D inductance of synchronous motor	0.01mH ~ 655.35mH	Per model	○	0x516
F5.23	Shaft Q inductance of (synchronous motor	0.01mH ~ 655.35mH	Per model	○	0x517
F5.24	Back EMF of synchronous motor of	0.1V ~ 1000.0V	Per model	○	0x518
F5.25	Encoder installation angle of PM	0.0° ~ 360.0°	Per model	○	0x519

F5.26	Inject frequency at high speed	50.0Hz ~ 1000.0Hz	300.0Hz	○	0x51A
F5.27	Inject voltage at high speed	0.1% ~ 100.0%	20.0%	○	0x51B
F5.28	Back EMF identify current	0.1% ~ 100.0%	80.0%	○	0x51C

★ Vector Control Parameters

Function code	Function name	Setting range and definition	Default setting	property	Comm. Add
F6.00	ASR(Speed loop) proportional gain 1	0.00 ~ 1.00	0.20	●	0x600
F6.01	ASR(Speed loop) integral time 1	0.01 ~ 10.00s	0.50s	●	0x601
F6.02	ASR(speed loop) derivative time 1	0.0 ~ 100.0	0.0	●	0x602
F6.03	ASR filter time 1	0.000 ~ 0.100s	0.005s	●	0x603
F6.04	ASR switching frequency 1	0.00 ~ 50.00Hz	5.00Hz	●	0x604
F6.05	ASR(Speed loop) proportional gain 2	0.00 ~ 1.00	0.20	●	0x605
F6.06	ASR(Speed loop) integral time 2	0.01 ~ 10.00s	0.50s	●	0x606
F6.07	ASR(speed loop) derivative time 2	0.0 ~ 100.0s	0.0s	●	0x607
F6.08	ASR filter time 2	0.000 ~ 0.100s	0.005	●	0x608
F6.09	ASR switching frequency 1	0.00 ~ 50.00Hz	10.00Hz	●	0x609
F6.51	Flux strength reference	0 ~ 500%	100%	●	0x633
F6.52	Flux control proportional gain	0 ~ 9999	2000	●	0x634
F6.53	Flux control integral gain	0 ~ 9999	2000	●	0x635

★ Fault and Protection Parameters

Function code	Function name	Setting range and definition	Default setting	property	Comm. Add
FA.10	DC bus under voltage protection point	50.0% ~ 100.0%	70.0%	●	0xA0A

★ Communication Control Function Parameters

Function code	Function name	Setting range and definition	Default setting	property	Comm. Add
Fd.00	Master-slave selecting(485 Can)	LED 1 digit : 485 communication mast to slave : LED 10 digit : Can selection : 0 : Master 1 : Slave	0	<input type="radio"/>	0xD00
Fd.02	Communication baud selection	LED 1 digit : 485 communication : 0 : 1200 bps 1 : 2400 bps 2 : 4800 bps 3 : 9600 bps 4 : 19200 bps 5 : 38400 bps 6 : 57600 bps 7 : 115200 bps LED 10 digit : Can communication 0 : 20 kbps 1 : 50 kbps 2 : 100kbps 3 : 125kbps 4 : 250kbps 5 : 500kbps 6 : 1Mbps	43	<input type="radio"/>	0xD02
Fd.10	RS485 communication protocol	0 : Modbus protocol 1 : Virtual oscilloscope 2 : Reserve	0	<input type="radio"/>	0xD0A

Note: If you need a detailed description of parameters, please contact the manufacturer to order "AC100 Vector Inverter".

★ Photovoltaic Pump Special Parameters

Function code	Function name	Setting range and definition	Default setting	property	Comm. Add
FE.00	Solar pump drive control mode	0 : Variable frequency control mode 1 : CVT mode for solar 2 : MPPT mode for solar	2	<input type="radio"/>	0xE00

FE.01	Running control mode	0 : Stop 1 : Running 2 : Sleep 3 : Low speed protection 4 : Dry run protection 5 : Over current protection 6 : Minimum power protection	Read only		0xE01
FE.02	VOC voltage(display)	0.0 ~ 999.9V	Read only		0xE02
FE.03	CVT target voltage	70.0 ~ 95.0%	81.0%	●	0xE03
FE.04	MPPT upper limit voltage	20.0 ~ 200.0%	100.0%	●	0xE04
FE.05	MPPT lower limit voltage	20.0 ~ 200.0%	50.0%	●	0xE05
FE.06	Frequency adjusting gain	0.1 ~ 500.0%	10.0% (AM) 40.0% (PMSM)	●	0xE06
FE.07	MPPT search interval	0.1 ~ 100.0	1.0s	●	0xE07
FE.08	MPPT regulating gain	0 ~ 9999	100	●	0xE08
FE.09	Quick-drop frequency gain	0 ~ 20	2	●	0xE09
FE.10	Frequency adjusting filter time	0.001 ~ 2.000 s	0.001	●	0xE0A
FE.11	Go to sleep mode voltage	0 ~ 1000V	0V	●	0xE0B
FE.12	Wake up restore voltage	0 ~ 1000V	400V	●	0xE0C
FE.13	Sleeping stop restore waiting time	0.0 ~ 3000.0s	10.0s	●	0xE0D
FE.14	Low speed protection detect frequency	0.00 ~ 300.00Hz	10.00Hz	●	0xE0E
FE.15	Low speed protection detect time	0.0 ~ 3000.0s	10.0s	●	0xE0F
FE.16	Low speed protection restore working time	0.0 ~ 3000.0s	10.0s	●	0xE10
FE.17	Dry run protection detect current	0.0 ~ 999.9A	0.0A	●	0xE11
FE.18	Dry run protection detect time	0.0 ~ 3000.0s	10.0s	●	0xE12
FE.19	Dry run auto restore working time	0.0 ~ 3000.0s	10.0s	●	0xE13

FE.20	Over current point setting	0.0 ~ 999.9A	0.0A	●	0xE14
FE.21	Over current protection detect time	0.0 ~ 3000.0s	10.0s	●	0xE15
FE.22	Over current protection auto restore working time	0.0 ~ 3000.0s	10.0s	●	0xE16
FE.23	Input minimum power protection power point setting	0.00 ~ 650.00kw	0.00kw	●	0xE17
FE.24	Minimum power protection detect time	0.0 ~ 3000.0s	10.0s	●	0xE18
FE.25	Minimum power protection auto restore working time	0.0 ~ 3000.0s	10.0s	●	0xE19
FE.26	Fault alarm restore mode	0 : Auto reset; 1 : Reset by manual LED0 : Low speed protection LED1 : Dry run LED2 : Over current protection LED3: Minimum power protection	0000	●	0xE1A
FE.27	Water fulfilled detect time	0.0s ~ 3000.0s	10.0s	●	0xE1B
FE.28	Water fulfilled restore time	0.0s ~ 3000.0s	10.0s	●	0xE1C
FE.29	reserve			●	0xE1D
FE.30	DC current revise offset	0.00 ~ 99.99A	0.01A	●	0xE1E
FE.31	DC current revise proportion gain	0.0 ~ 999.9%	100.0%	●	0xE1F
FE.32	Power curve point 0	0.00 ~ 99.99kw	0.50kw	●	0xE20
FE.33	Power curve point 1	0.00 ~ 99.99kw	1.00kw	●	0xE21
FE.34	Power curve point 2	0.00 ~ 99.99kw	1.50kw	●	0xE22
FE.35	Power curve point 3	0.00 ~ 99.99kw	2.00kw	●	0xE23
FE.36	Power curve point 4	0.00 ~ 99.99kw	2.50kw	●	0xE24
FE.37	Flow curve point 0	0.0 ~ 999.9m3/h	0.0 m3/h	●	0xE25
FE.38	Flow curve point 1	0.0 ~ 999.9m3/h	5.0 m3/h	●	0xE26
FE.39	Flow curve point 2	0.0 ~ 999.9m3/h	10.0 m3/h	●	0xE27
FE.40	Flow curve point 3	0.0 ~ 999.9m3/h	15.0 m3/h	●	0xE28
FE.41	Flow curve point 4	0.0 ~ 999.9m3/h	20.0 m3/h	●	0xE29

FE.42	Flow calculating revise offset	0.0 ~ 999.9m3	0.0m3	●	0xE30
FE.43	Flow calculating revise gain	0.0 ~ 999.9%	100.0%	●	0xE31
FE.44	Power per day/ generated power per day reset period	0.0 ~ 24.0h	7.0h	●	0xE32
FE.45	Reserved			●	0xE33
FE.46	Photovoltaic pump function selection 1	0 : Invalid 1 : Valid LED0 : Constant torque frequency limit selection LED1 : Reserved LED2 : Voltage rising update Voc voltage LED3: Fast frequency falling function	1100H	●	0xE34
FE.47	Fast frequency falling threshold	3.0% ~ 15.0%	5.0%	●	0xE35
FE.48	Constant torque frequency limit coefficient	80.0% ~ 150.0%	100.0%	●	0xE36
FE.49	Sudden voltage increase threshold	0.0% ~ 20.0%	5.0%	●	0xE37
FE.50	Reserved			●	0xE38

★ Photovoltaic Pump Special Monitor Parameters

Function code	Function name	Setting range and definition	Default setting	property	Comm. Add
C-00	Frequency reference	0.01Hz	Read only		2100H
C-01	Output frequency	0.01Hz	Read only		2101H
C-02	Output current	0.1A	Read only		2102H
C-04	Output voltage	0.1V	Read only		2104H
C-10	Output power	0.01kw	Read only		210AH
C-11	DC bus voltage	0.1V	Read only		210BH
C-30	DC current	0.01A	Read only		211EH
C-31	Flow speed	0.1 m3/h	Read only		211FH
C-32	Voc voltage	0.1 V	Read only		2120H
C-33	Flow per day	0.1 m3	Read only		2121H
C-34	Cumulative total flow(low position)	0.1m3	Read only		2122H

C-35	Cumulative total flow(high position)	0.1km3	Read only		2123H
C-36	Generated power per day	0.1kwh	Read only		2124H
C-37	Cumulative total generated power (low position)	0.1kwh	Read only		2125H
C-38	Cumulative total generated power (high position)	0.1Mwh	Read only		2126H

Input terminals ON/OFF status illustration

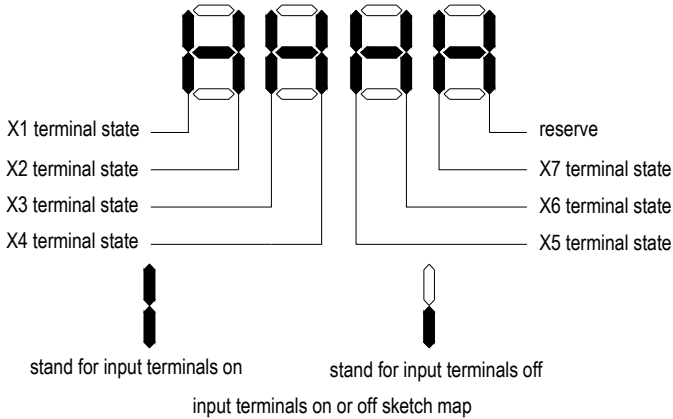

Output terminals ON/OFF status illustration

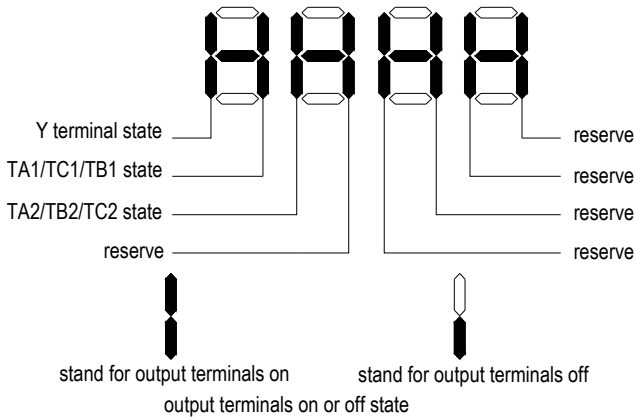

Chapter 6 Operation Guidance

6.1 Asynchronous Motor Pump Drive Operation Guidance

1) Wiring:

- a. Confirmed the solar pump drive if mating with motor.
- b. Connecting “+”“—” of solar panel to corresponding “+”“—” of inverter or R, T wiring terminals. Otherwise it will cause inverter damage.
- c. Connect motor wire and ground wire to corresponding U, V, W, E terminals.

2). Parameters setting and trial run:

- a. Set F0.00 to 1, F0.02 for 0, and F0.09, F0.11, F0.14, F0.15 parameters setting according to application site.
- b. Set motor(pump) parameters according to nameplate of pump
- c. Set solar pump MPPT mode FE.001 for 1 or 2
- d. Press FWD button for trail running, and confirm the motor running direction.

3) Common problems

- a, Q : Well-lit conditions, the pump is running, but the water is very small.
A : Check if the pump motor direction is reversed.
- b, Q : Well-lit conditions, the drive is in standby mode 0.00Hz
A : Check FE.01, observe what protection status is the drive in currently, check whether the parameters set is reasonable; if acceleration and deceleration time is too long,during the drive running in the low frequency protection detection time, the output frequency is lower than protection threshold and the low-frequency protection starts.
- c, Q : DC current is incorrectly displayed.
A : Adjust FE.22, FE.23 for calibration.
- d, Q : Well-lit conditions, frequency severe beating during operation.
A : Reasonably adjust FE.06 value, the adjustment is recommended to be in the vicinity of the default, too big or too small will cause frequency oscillation;

6.2 Synchronous Motor Pump Drive Operation Guidance

1) Wiring:

- a. Confirm if the solar pump drive matches with the motor.
- b. Connecting “+”“-” of solar panel to corresponding “+”“-” of inverter or R, T wiring terminals. Otherwise it will cause inverter damage.
- c. Connect motor wire and ground wire to corresponding U, V, W, E terminals.

2) Parameters setting and trial run:

- a) . Set F0.00 to 6, F0.02 for 0, and F0.09=100.00, F0.11=100.00; F0.14, F0.15 can be set according to demand.

b). Set motor (pump) parameters according to nameplate of pump. Then Set F5.12 for 1, the keypad will show T-00, press FWD to start motor auto tuning. This process takes about three minutes;

Note: 1. If you can disconnect the motor and load, self-learning would be better;.

2. The self-learning need to be done with enough sunshine and when the solar panels can provide enough energy.

c). Set solar pump MPPT mode FE.001 for 1 or 2

d). Press FWD button for trail running, and confirm the motor running direction.

3) Common problems and solutions

a, Q : Well-lit conditions, the pump is running, but the water is very small.

A : Check if the pump motor direction is reversed.

b, Q : Well-lit conditions, the drive is in standby mode 0.00Hz

A : Check FE.01, observe what protection status is the drive in currently, check whether the parameters set is reasonable; if acceleration and deceleration time is too long,during the drive running in the low frequency protection detection time, the output frequency is lower than protection threshold and the low-frequency protection starts.

c, Q : DC current is incorrectly displayed.

A : Adjust FE.22, FE.23 for calibration.

d, Q : Well-lit conditions, frequency severe beating during operation.

A : Reasonably adjust FE.06 value, the adjustment is recommended to be in the vicinity of the default, too big or too small will cause frequency oscillation;

e, Q : The current fluctuation is huge when the pump is running.

A : Check C-39, adjusting the value of F5.24, so the C-39 displays the value from 0-10;

6.3 PV Water Pump Features

A. Sleep Function

During the photovoltaic pump operation, the inverter will go into sleep state when the DC voltage provided by solar panels is lower than FE.11 (sleep voltage threshold) due to objective factors, while the keyboard warning "A.LPn"; when DC voltage provided by solar panels rises back to FE.12 (sleep recovery voltage) point, start timing and after FE.13 (sleep shutdown waiting time), the drive starts running;

B. Low-frequency Protection Function

During the operation of the photovoltaic pump, for some reason, the output frequency is lower than FE.14 (low frequency detection frequency), and after FE.15 (under frequency detection time) time, enters into the standby protection state, while the keyboard warning "A.LFr"; after entering into the standby protection state and after FE.16 (frequency protection automatic recovery) time, automatically resume to running state;

C. Dry Run Protection

During the operation of the photovoltaic pump, for some reason, the output current is less than FE.17 (dry protection current detection), and after FE.18 (dry protection detection time) time, enters into standby protection state, while the keyboard warning "A.LuT"; after entering into the standby protection state and after FE.19 (dry protection automatic recovery)time, automatically resume to running state;

D. Over-current Protection

During the operation of the photovoltaic pump, for some reason, the output current is greater than FE.20(dry protection current detection), and after FE.21 (dry protection detection time) time, enters into standby protection state, while the keyboard warning "A.LuT"; after entering into the standby protection state and after FE.22 (dry protection automatic recovery)time, automatically resume to running state;

E. Minimum Power Protection

During the operation of the photovoltaic pump, for some reason, the output power is less than FE.23(minimum power protection value), and after FE.24 (minimum power protection detection time) time, enters into standby protection state, while the keyboard warning "A.LPr"; after entering into the standby protection state and after FE.25 (minimum power automatic recovery)time, automatically resume to running state;

F. Full Water Protection

Detect the water full alarm and low water level through two X terminals, realizing automatic level control. Wherein FE.27 is the water overflow protection detection time and FE.28 is full water protection exit time, and X terminal is defined as 10 (full solar water detection alarm), and when defined as the 11 (full solar water detection alarm reset), the warning signal is shown as "A.Ful"

G. Alarm Recovery Mode: 0: automatic recovery; 1: manual recovery

This option is for low frequency protection, dry protection, over-current protection, minimum power function; you can select the alarm restoration by FE.26. When you select 0 for automatic recovery, during fault warning displaying, you can also press the "RESET" button to stop operation; during fault warning displaying, you can press the "RESET" button to manually clear, you can also press "RESET" button to achieve stop operation.

H. PQ Curve Function

This model provides a self-defined PQ curve for users to set up five groups of PQ corresponding points according to the pump cases, to achieve real-time traffic speed, daily flow, cumulative flow, generating capacity, cumulative electricity consumption; of which by default, daily flow and generating capacity are calculated based on 7h in a day.

I. Status Check

When the photovoltaic pump is running, you can check FE.01 to confirm the current operating status.

Warranty Card

Profile

User Name : _____

Address : _____

Contacts : _____ Phone : _____ Fax : _____

Model : _____ Machine Code : _____

Agent/Distributor Profile

Delivery Company : _____

Contacts : _____ Phone : _____ Delivery Date : _____

Warranty Clauses

The Company solemnly states that since the day users purchase from my company (hereinafter referred to as manufacturer), they can enjoy the following warranty services:

1. Since the date of purchase, users can enjoy the following warranty services of the product:
- 1) Within 30 days after shipment, the company promises returning, replacement and maintenance of the product.
 - 2) Within 90 days after shipment, the company promises replacement and maintenance of the product.
 - 3) Within 18 months after shipment, the company promises only maintenance of the product.
 - 4) Products exported to countries except China shall not enjoy the warranties mentioned above.

2. Since the date of purchase, users can enjoy the service of the company when they pay for the service.

3. Exception Clauses: Product failures caused by the following reasons would not enjoy the free warranty services of the manufacturer:

- 1) Failures caused by operations of users that is not operated in accordance with the requirements of the product manual;
- 2) Failures caused when users repair or renovate the product without communicating with the manufacturer in advance;
- 3) Failures caused by abnormal aging of the product resulted from poor using environment;
- 4) Failures caused by earthquake, fire or other natural disasters or abnormal voltage;
- 5) Failures caused by damage during transportation (mode of transportation is decided by users and the company only helps to handle cargo shipment procedures).

4. In the following conditions, the manufacturer have the right not to provide warranty services:

- 1) When the marks, trademarks or nameplates of the products are destroyed or can not be identified;
- 2) When users do not pay for the product according to signed contract;
- 3) When users intentionally hiding the improper operations during installation, wiring and maintenance;

5. For products that enjoy all returning, replacement and maintenance services, first the product should be returned to the company and after responsibility confirmation, the product can be replaced or repaired.

Certificate of Approval

QC check :



The product has been checked and proved to be qualified for delivery in conformity with standard.